

DIMENSIONS

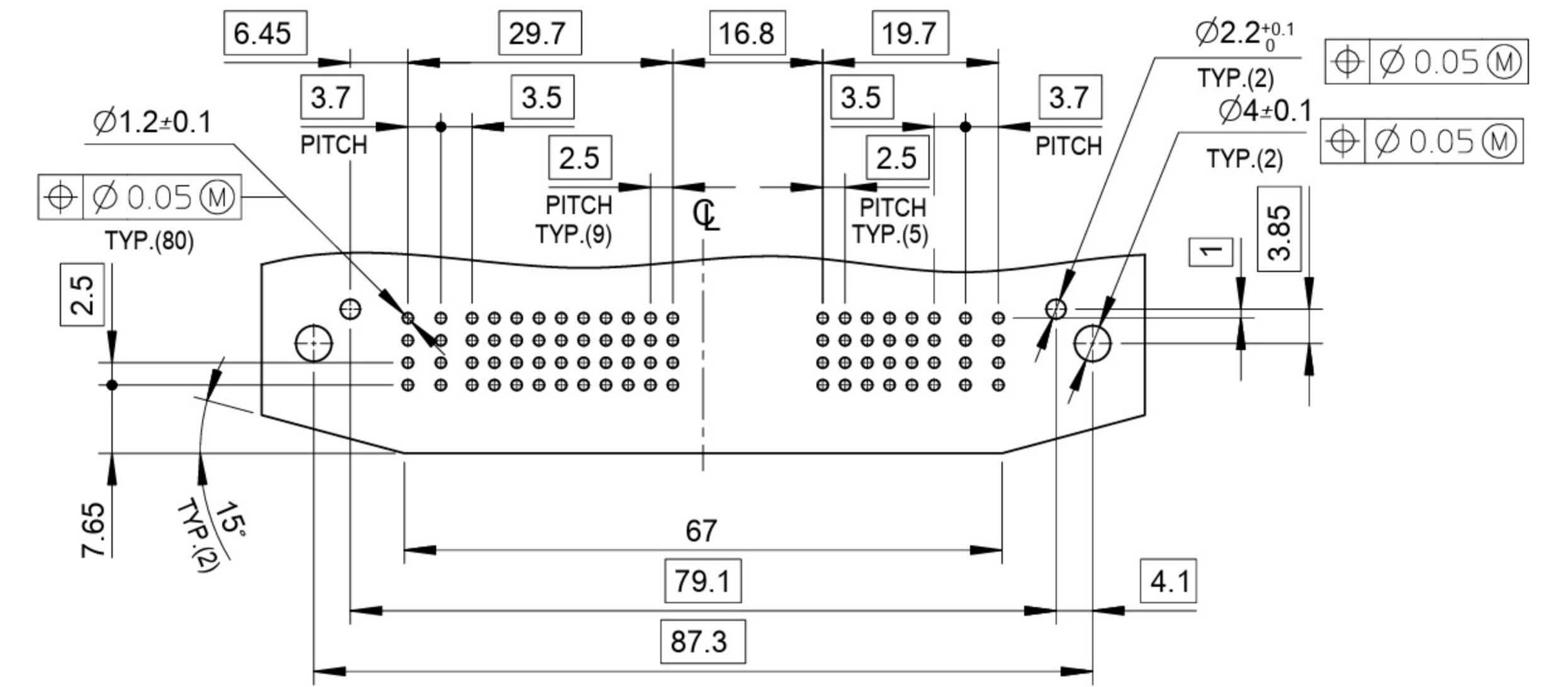

基板穴推奨寸法 (部品実装側)
RECOMMENDED PCB LAYOUT (COMPONENT SIDE)

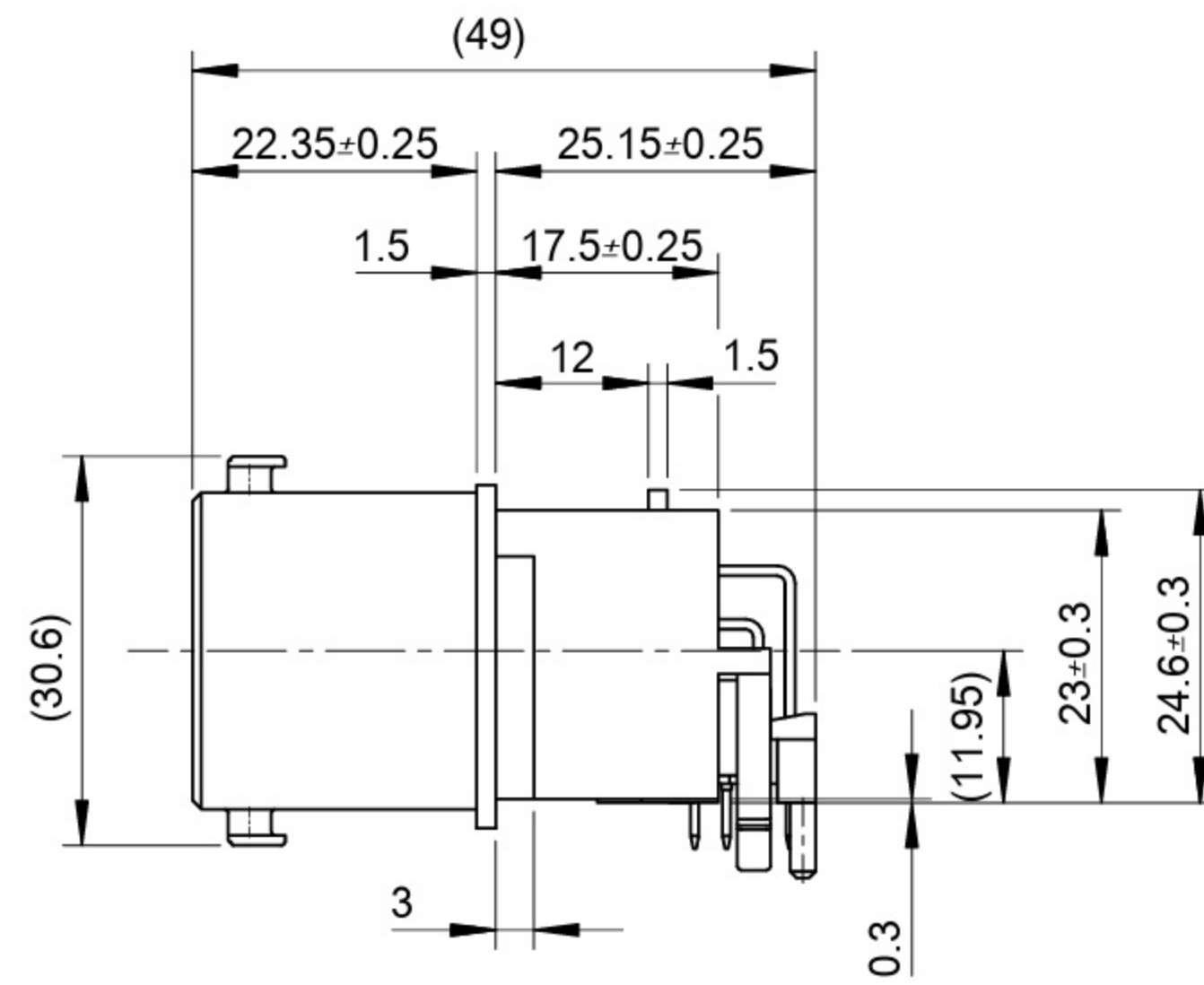
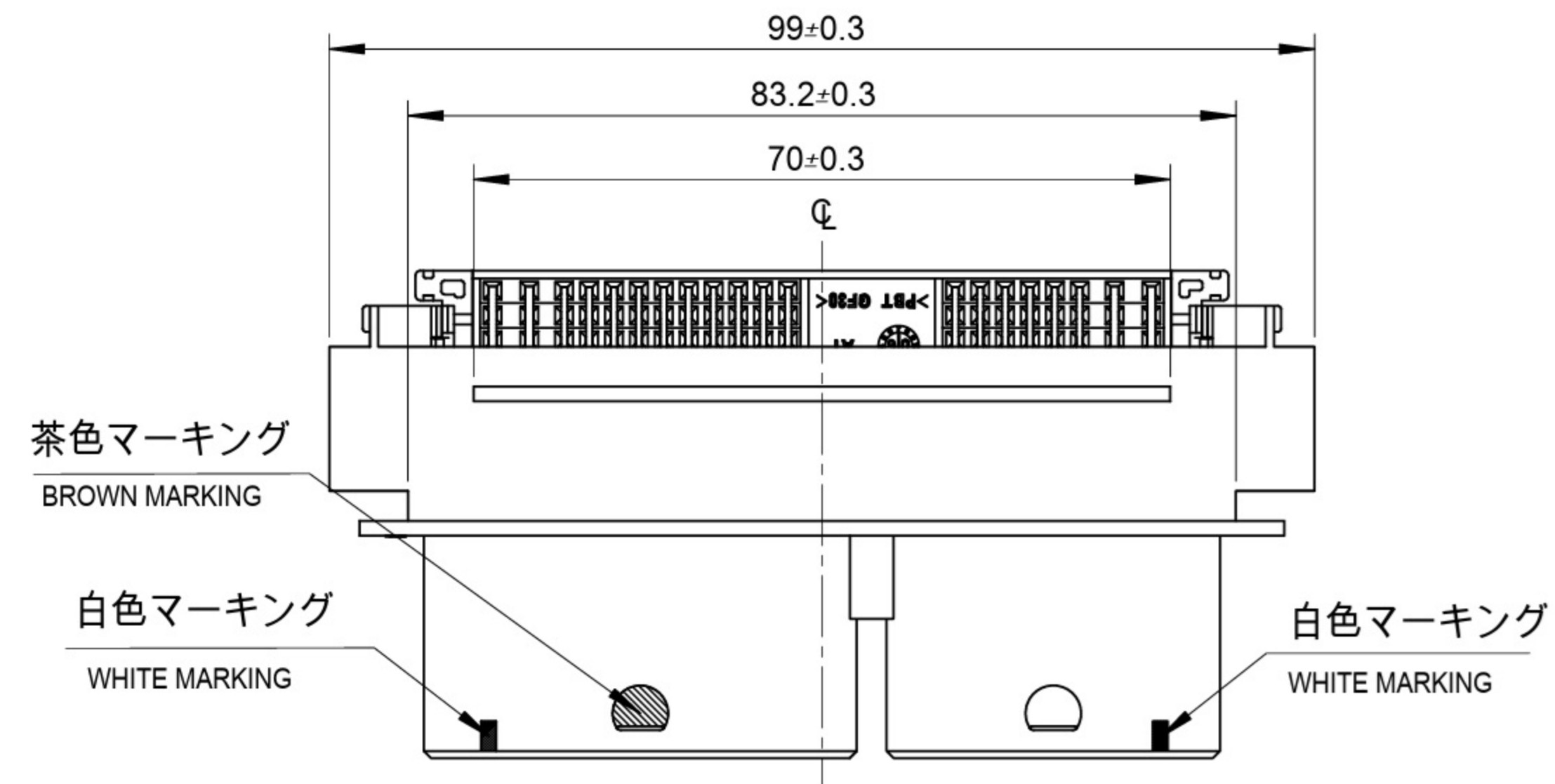
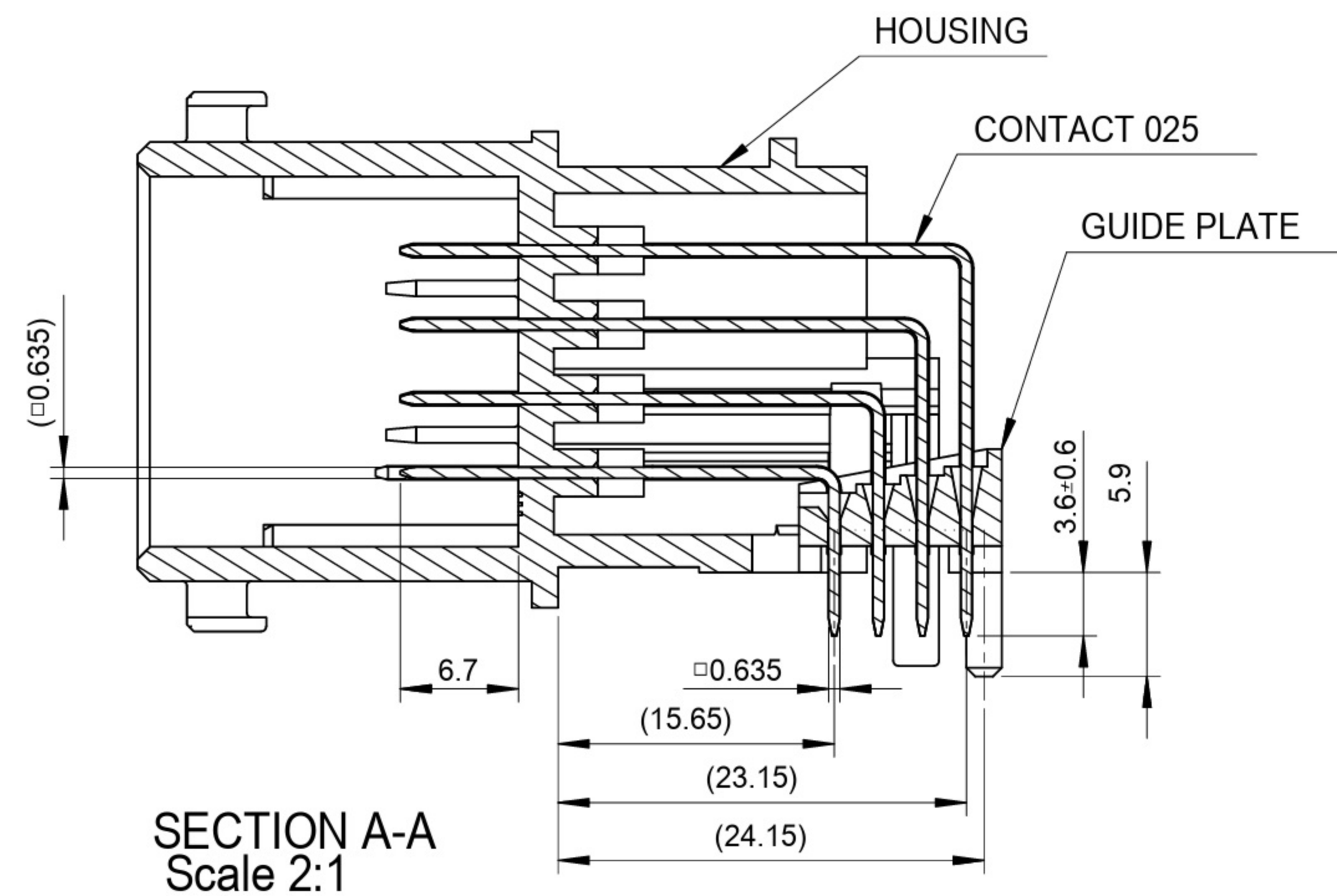
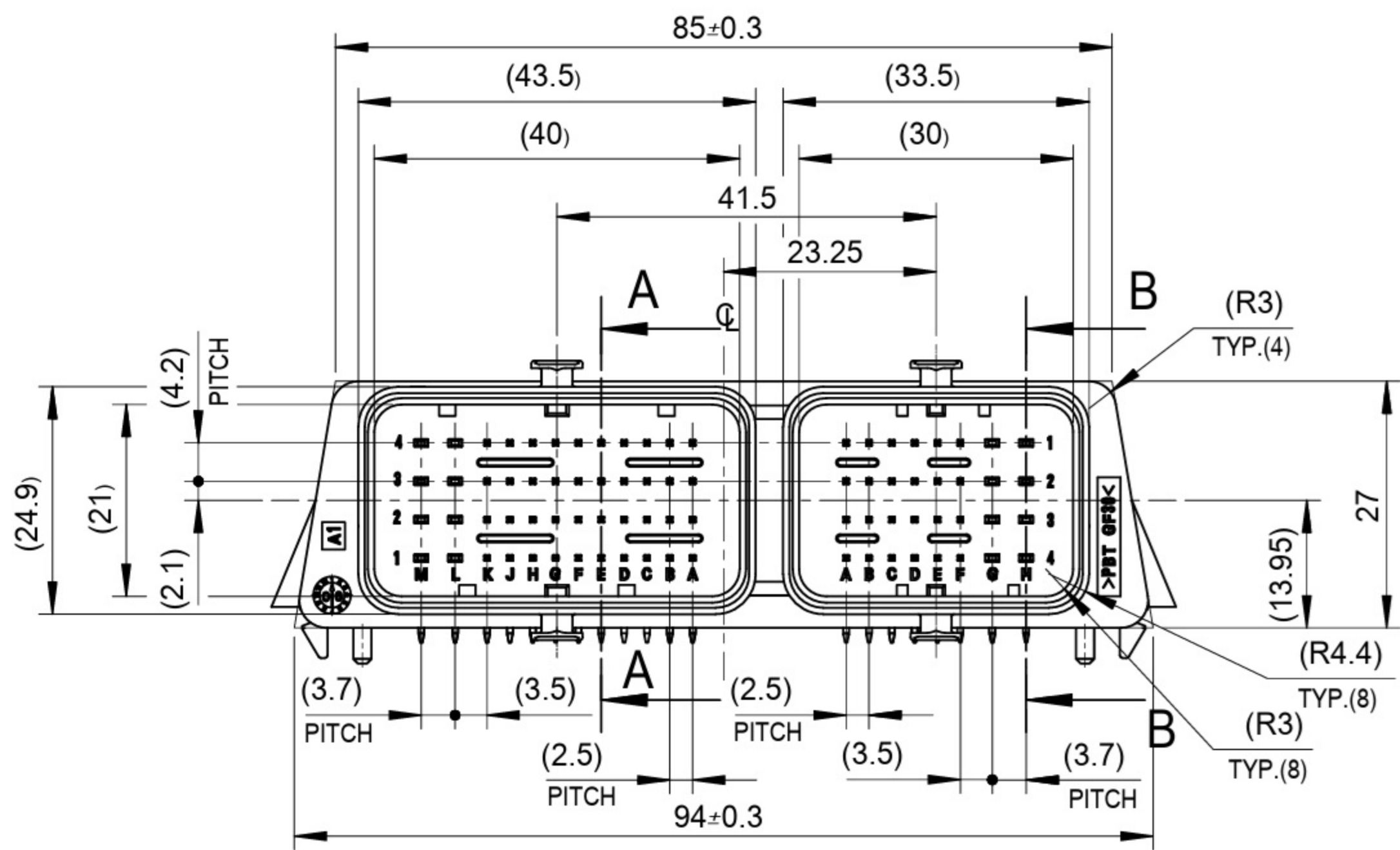

SECTION A-A
Scale 2:1

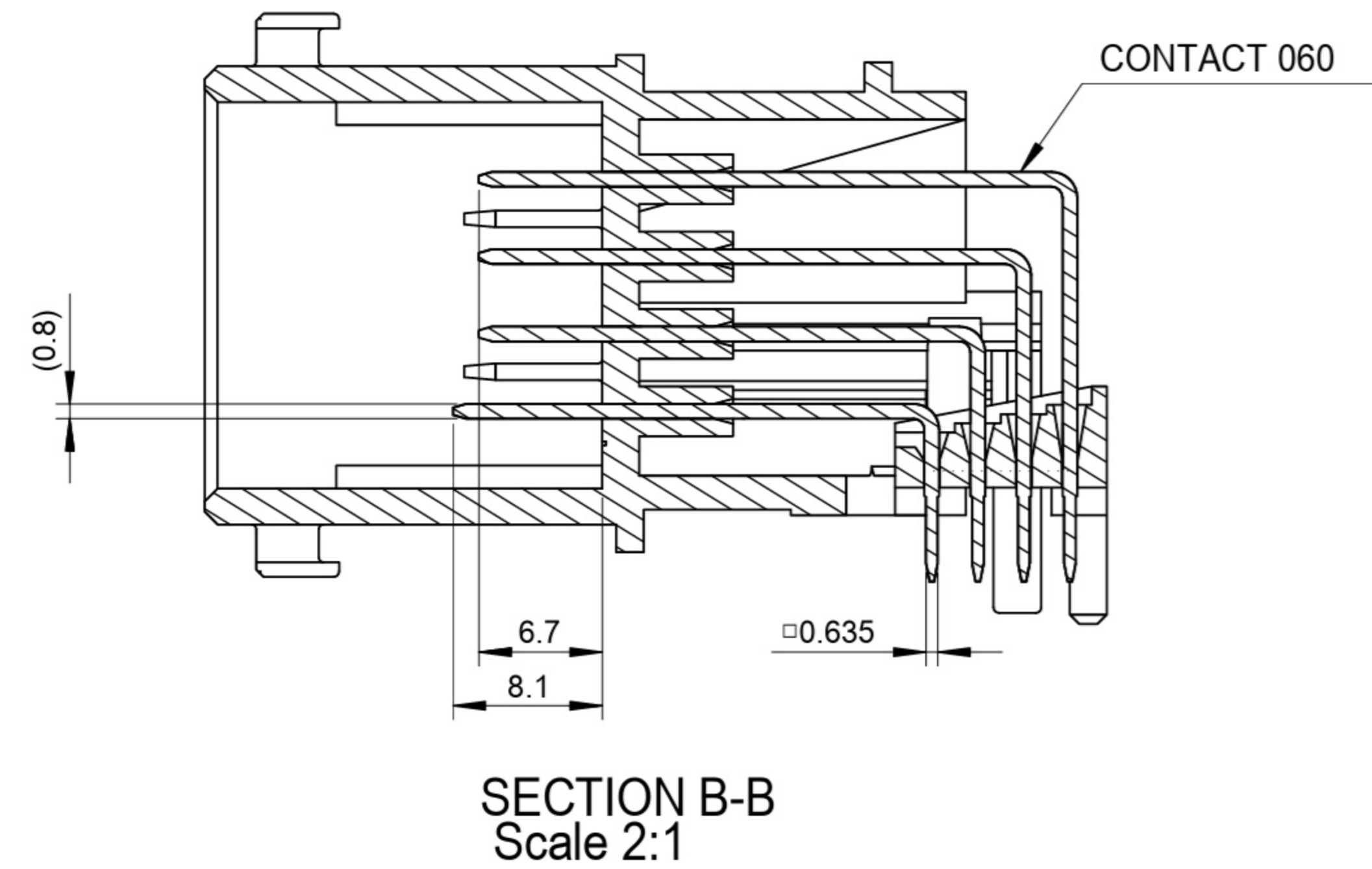
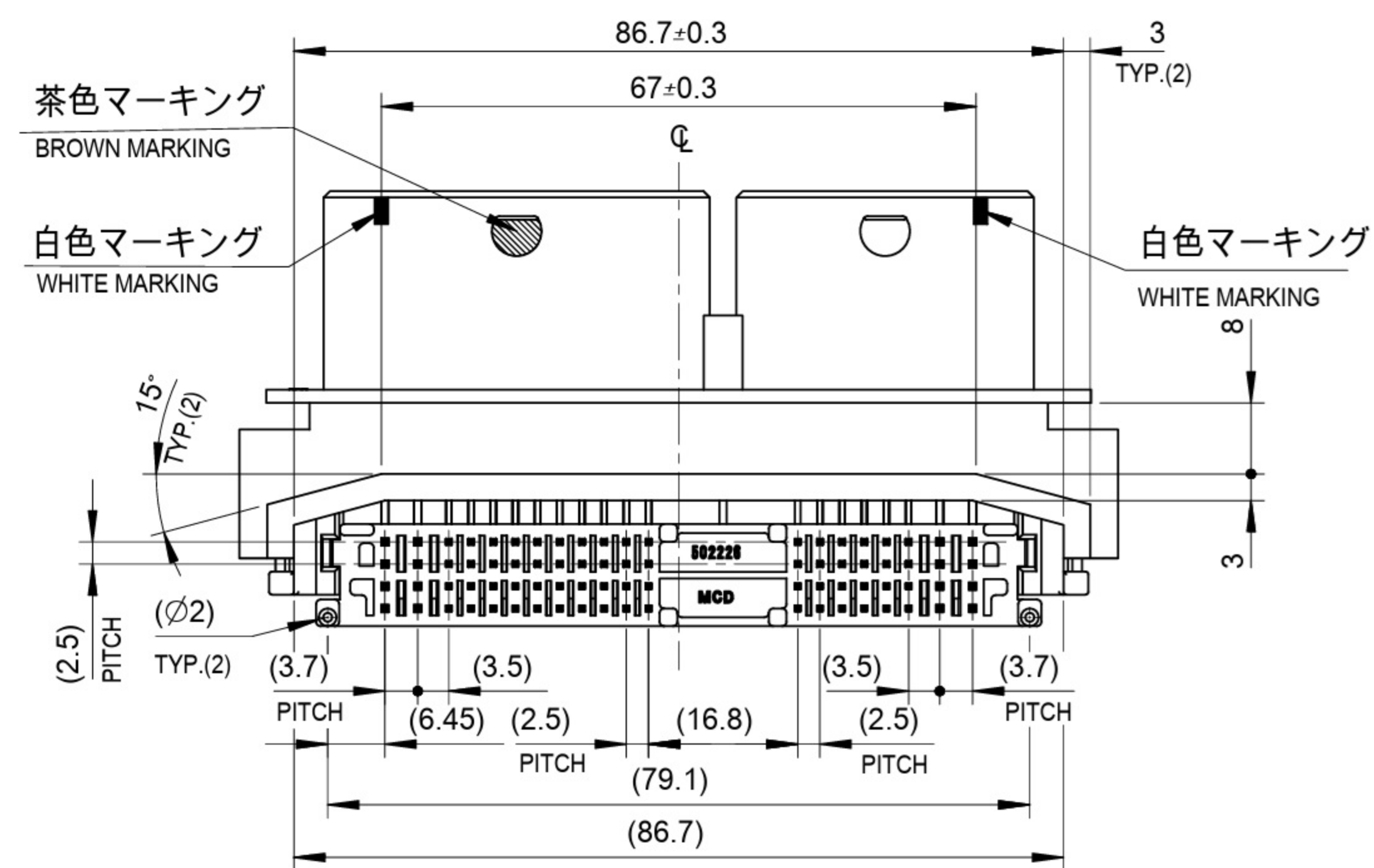
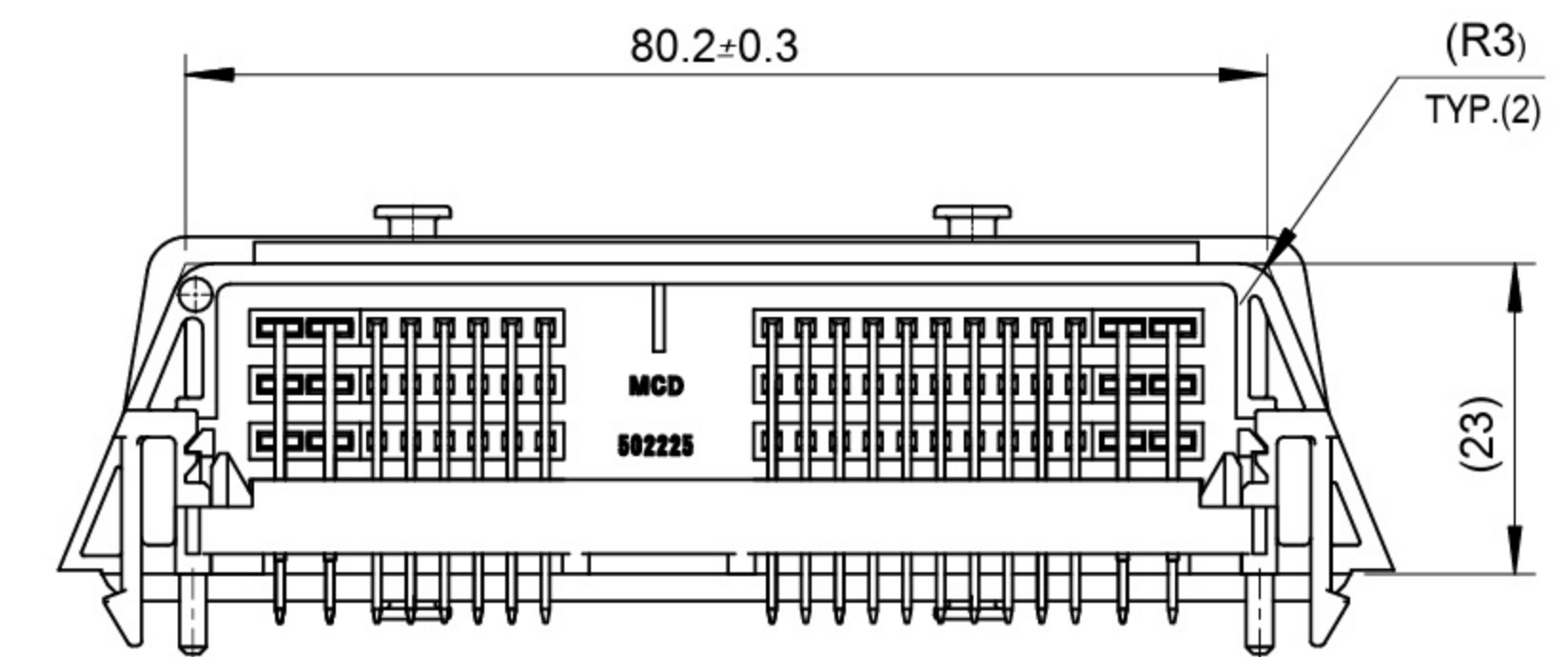

SECTION B-B
Scale 2:1